

Product Specification

SPECIFICATION FOR APPROVAL

- (V) Preliminary Specification
() Final Specification

Title	14.1" WXGA TFT LCD
-------	--------------------

Customer	Dell
MODEL	

SUPPLIER	LG.Philips LCD Co., Ltd.
*MODEL	LP141WX1
Suffix	TL01

*When you obtain standard approval,
please use the above model name without suffix

SIGNATURE	DATE
/	_____
/	_____
/	_____

Please return 1 copy for your confirmation with your signature and comments.

SIGNATURE	DATE
J.H. Lee / G.Manager	_____
REVIEWED BY	
J.H. Park / Manager	_____
PREPARED BY	
C.I. Kim / Engineer	
M.K.BAE / Engineer	_____

**Products Engineering Dept.
LG. Philips LCD Co., Ltd**

Product Specification

Contents

No	ITEM	Page
	COVER	1
	CONTENTS	2
	RECORD OF REVISIONS	3
1	GENERAL DESCRIPTION	4
2	ABSOLUTE MAXIMUM RATINGS	5
3	ELECTRICAL SPECIFICATIONS	
3-1	ELECTRICAL CHARACTREISTICS	6
3-2	INTERFACE CONNECTIONS	7
3-3	SIGNAL TIMING SPECIFICATIONS	9
3-4	SIGNAL TIMING WAVEFORMS	9
3-5	COLOR INPUT DATA REFERNECE	10
3-6	POWER SEQUENCE	11
4	OPTICAL SFECIFICATIONS	12
5	MECHANICAL CHARACTERISTICS	16
6	RELIABLITY	20
7	INTERNATIONAL STANDARDS	
7-1	SAFETY	21
7-2	EMC	21
8	PACKING	
8-1	DESIGNATION OF LOT MARK	22
8-2	PACKING FORM	22
9	PRECAUTIONS	23
A	APPENDIX. Enhanced Extended Display Identification Data (EEDID™)	25
		27

Product Specification

RECORD OF REVISIONS

Revision No	Revision Date	Page	Description	EDID ver
0.0	Feb. 22, 2005	-	First Draft	V0.0
0.1	Mar. 30, 2005	-		
0.2	Apr. 06, 2005	-	Lamp life time changed 12,000 -> 15,000 hrs	
0.3	May. 10, 2005	11	Changed the Item(Table8. Power Sequence Table) T7 : 1000 → 400	V0.1
		13	Changed the Item(The numerical formula of the the variation in surface luminance)	
		25~27	Added the Item(EEDID Data)	
0.4	Jun. 16, 2005	4	Changed the Item(Added ROHS Comply)	V0.4
		6	Changed the Item(Electrical Characteristics)	
		11	Changed the Item(Power Sequence T6(Max.) 100ms → 10ms)	
		12	Changed the Item(Optical Characteristics)	
		13	Changed the Item(Gray Scale)	
		25~27	Changed the Item (Added SMBUS and Color coordinates)	
0.5	Jun. 22, 2005	8	Changed the Item (Low voltage back Light Connector Color : White → Green)	V0.5
		12	Changed the EEDID Data (Optical Characteristics, Response Time, Typ & Max)	
		4, 16	Changed the Item (LCM weight : Typ. Max.)	
		17~19	Changed the Figure (LCM View)	
		22	Changed the Figure (LCM Packing Spec.)	
		25~27	Changed the EEDID Data (Changed SMBUS Data, Revision #, and Check Sum)	
0.6	July. 02. 2005	9	Changed the Timing Table(Typ. Is equal to EEDID Timing Data)	V0.6
		26, 27	Changed the EDID Data (Added the Dell P/N, revised the EEDID revision number)	
0.7	July. 15. 2005	9	Changed the Timing Table(Typ. Is equal to VESA Standard EEDID Timing Data)	V0.7
		25~27	Changed the EDID Data	
0.8	Aug. 10. 2005	21	Changed the International Standards	V0.8
		25~27	Changed the Data(Changed EEDID Format & SMBUS Data)	

Product Specification

1. General Description

The LP141WX1 is a Color Active Matrix Liquid Crystal Display with an integral Cold Cathode Fluorescent Lamp (CCFL) backlight system. The matrix employs a-Si Thin Film Transistor as the active element. It is a transmissive type display operating in the normally white mode. This TFT-LCD has 14.1 inches diagonally measured active display area with WXGA resolution(800 vertical by 1280 horizontal pixel array). Each pixel is divided into Red, Green and Blue sub-pixels or dots which are arranged in vertical stripes. Gray scale or the brightness of the sub-pixel color is determined with a 6-bit gray scale signal for each dot, thus, presenting a palette of more than 262,144 colors.

The LP141WX1 has been designed to apply the interface method that enables low power, high speed, low EMI.

The LP141WX1 is intended to support applications where thin thickness, low power are critical factors and graphic displays are important. In combination with the vertical arrangement of the sub-pixels, the LP141WX1 characteristics provide an excellent flat display for office automation products such as Notebook PC.

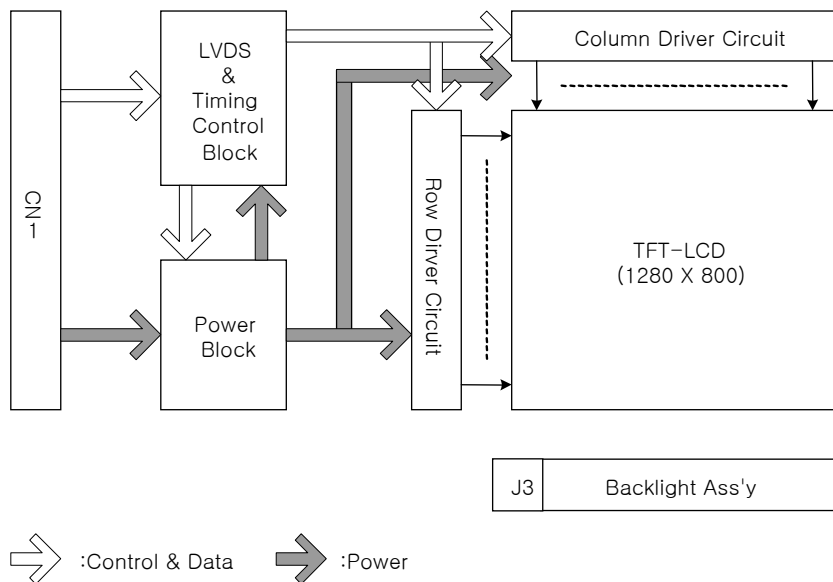

General Features

Active Screen Size	14.1 inches diagonal
Outline Dimension	320 (H) × 206(V) × 5.5(D, max) mm
Pixel Pitch	0.2373 mm × 0.2373 mm
Pixel Format	1280 horiz. By 800 vert. Pixels RGB strip arrangement
Color Depth	6-bit, 262,144 colors
Luminance, White	185 cd/m ² (Typ.5 point)
Power Consumption	Total 5.2 Watt(Typ.) @ LCM circuit 1.1Watt(Typ.), B/L input 4.1Watt(Typ.)
Weight	425 g (Max.), 415g(Typ.)
Display Operating Mode	Transmissive mode, normally white
Surface Treatment	Anti-glare treatment of the front polarizer
RoHS Comply	Yes

Product Specification

2. Absolute Maximum Ratings

The following are maximum values which, if exceeded, may cause faulty operation or damage to the unit.

Table 1. ABSOLUTE MAXIMUM RATINGS

Parameter	Symbol	Values		Units	Notes
		Min	Max		
Power Input Voltage	VCC	-0.3	4.0	Vdc	at 25 ± 5°C
Operating Temperature	TOP	0	50	°C	1
Storage Temperature	HST	-20	60	°C	1
Operating Ambient Humidity	HOP	10	90	%RH	1
Storage Humidity	HST	10	90	%RH	1

Note : 1. Temperature and relative humidity range are shown in the figure below.
 Wet bulb temperature should be 39°C Max, and no condensation of water.

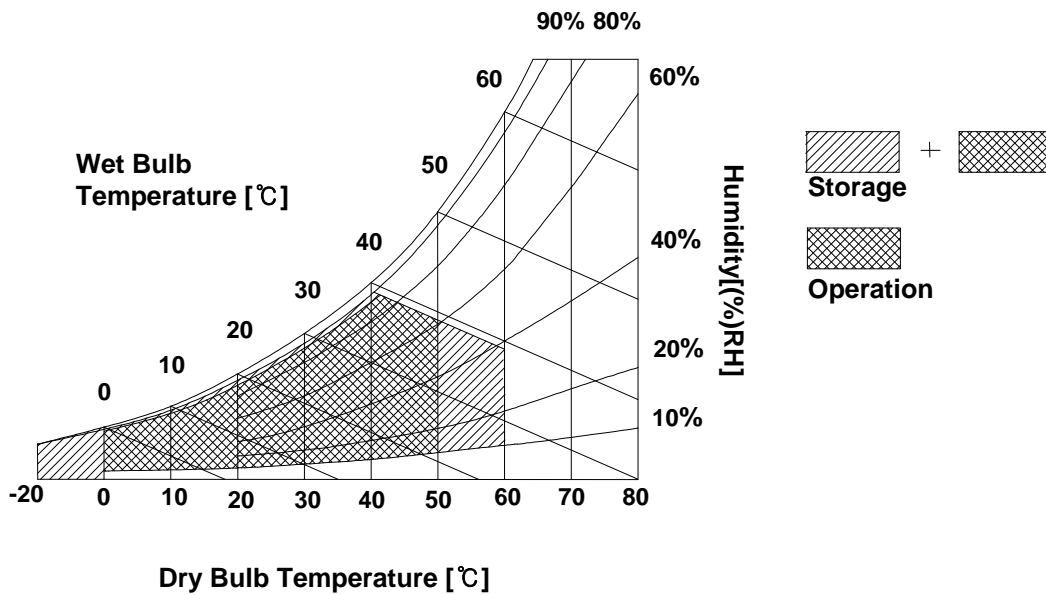

Product Specification

3. Electrical Specifications

3-1. Electrical Characteristics

The LP141WX1 requires two power inputs. One is employed to power the LCD electronics and to drive the TFT array and liquid crystal. The second input which powers the CCFL, is typically generated by an inverter. The inverter is an external unit to the LCD.

Table 2. ELECTRICAL CHARACTERISTICS

Parameter	Symbol	Values			Unit	Notes
		Min	Typ	Max		
MODULE :						
Power Supply Input Voltage	VCC	3.0	3.3	3.6	V _{DC}	
Power Supply Input Current	I _{CC}	-	320	420	Ma	1
Power Consumption	Pc	-	1.1	1.4	Watt	1
Differential Impedance	Zm	90	100	110	Ohm	2
LAMP :						
Operating Voltage	V _{BL}	640(TBD)	675(6.0mA)	880(2.0mA)	V _{RMS}	
Operating Current	I _{BL}	2.0	6.0	7.0	mA _{RMS}	3
Power Consumption	P _{BL}	-	4.1	4.5		
Operating Frequency	f _{BL}	50	65	80	kHz	
Discharge Stabilization Time	T _s	-	-	3	Min	4
Life Time		15,000	-	-	Hrs	5
Established Starting Voltage at 25 °C at 0 °C	Vs			1180 1415	V _{RMS} V _{RMS}	

Note)

- The specified current and power consumption are under the Vcc = 3.3V , 25 °C , fv = 60Hz condition whereas full black pattern is displayed and fv is the frame frequency.
- This impedance value is needed to proper display and measured form LVDS Tx to the mating connector.
- The typical operating current is for the typical surface luminance (L_{WH}) in optical characteristics.
- Define the brightness of the lamp after being lighted for 5 minutes as 100%, Ts is the time required for the brightness of the center of the lamp to be not less than 95%.
- The life time is determined as the time at which brightness of lamp is 50% compare to that of initial value at the typical lamp current.
- The output of the inverter must have symmetrical(negative and positive) voltage waveform and symmetrical current waveform.(Asymmetrical ratio is less than 10%) Please do not use the inverter which has asymmetrical voltage and asymmetrical current and spike wave.
Lamp frequency may produce interface with horizontal synchronous frequency and as a result this may cause beat on the display. Therefore lamp frequency shall be as away possible from the horizontal synchronous frequency and from its harmonics in order to prevent interference.
- It is defined the brightness of the lamp after being lighted for 5 minutes as 100%.
T_s is the time required for the brightness of the center of the lamp to be not less than 95%.
- The lamp power consumption shown above does not include loss of external inverter.
The applied lamp current is a typical one.

Product Specification

Note)

9. Requirements for a system inverter design, which is intended to have a better display performance, a better power efficiency and a more reliable lamp, are following.

It shall help increase the lamp lifetime and reduce leakage current.

- a. The asymmetry rate of the inverter waveform should be less than 10%.
- b. The distortion rate of the waveform should be within $\sqrt{2} \pm 10\%$.

* Inverter output waveform had better be more similar to ideal sine wave.

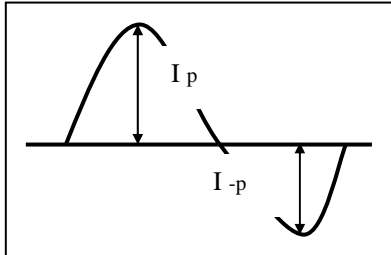

* Asymmetry rate:

$$\frac{|I_p - I_{-p}|}{I_{rms}} * 100\%$$

* Distortion rate

$$I_p \text{ (or } I_{-p}) / I_{rms}$$

※ Do not attach a conducting tape to lamp connecting wire.

If the lamp wire attach to a conducting tape, TFT-LCD Module has a low luminance and the inverter has abnormal action. Because leakage current is occurred between lamp wire and conducting tape.

Product Specification

3-2. Interface Connections

This LCD employs two interface connections, a 30 pin connector is used for the module electronics interface and the other connector is used for the integral backlight system.

The electronics interface connector is a model FI-XB30SRL-HF11 manufactured by JAE.

Table 3. MODULE CONNECTOR PIN CONFIGURATION (CN1)

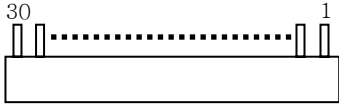
Pin	Symbol	Description	Notes
1	GND	Ground	<p>1. Interface chips 1.1 LCD : SW, SW0602_U(LCD Controller) including LVDS Receiver (UMC社 FXLVRX085H90A) 1.2 System : it must include international standard LVDS Transmitter. * Pin to Pin compatible with LVDS</p> <p>2. Connector 2.1 LCD : FI-XB30SRL-HF11, JAE or its compatibles 2.2 Mating : FI-X30M or equivalent. 2.3 Connector pin arrangement</p>  <p>[LCD Module Rear View]</p>
2	VCC	Power Supply, 3.3V Typ.	
3	VCC	Power Supply, 3.3V Typ.	
4	V EEDID	DDC 3.3V power	
5	NC	Reserved for supplier test point	
6	CLK EEDID	DDC Clock	
7	DATA EEDID	DDC Data	
8	R _{IN} 0-	Negative LVDS differential data input	
9	R _{IN} 0+	Positive LVDS differential data input	
10	GND	Ground	
11	R _{IN} 1-	Negative LVDS differential data input	
12	R _{IN} 1+	Positive LVDS differential data input	
13	GND	Ground	
14	R _{IN} 2-	Negative LVDS differential data input	
15	R _{IN} 2+	Positive LVDS differential data input	
16	GND	Ground	
17	CLKIN-	Negative LVDS differential clock input	
18	CLKIN+	Positive LVDS differential clock input	
19	GND	Ground	
20	NC	No Connect	
21	NC	No Connect	
22	NC	No Connect	
23	NC	No Connect	
24	NC	No Connect	
25	NC	No Connect	
26	NC	No Connect	
27	NC	No Connect	
28	NC	No Connect	
29	NC	No Connect	
30	NC	No Connect	

The backlight interface connector is a model BHSR-02VS-1, manufactured by JST or Compatible. The mating connector part number is SM02B-BHSS-1 or equivalent.

Table 5. BACKLIGHT CONNECTOR PIN CONFIGURATION (J3)

Pin	Symbol	Description	Notes
1	HV	Power supply for lamp (High voltage side)	1
2	LV	Power supply for lamp (Low voltage side)	1

Notes : 1. The high voltage side terminal is colored pink and the low voltage side terminal is Green.

3-3. Signal Timing Specifications

This is the signal timing required at the input of the User connector. All of the interface signal timing should be satisfied with the following specifications and specifications of LVDS Tx/Rx for its proper operation.

Table 6. TIMING TABLE

ITEM	Symbol	Min	Typ	Max	Unit	Note
DCLK	Frequency	f_{CLK}	66.9	71.0	75.4	MHz
Hsync	Period	T_{hp}	1380	1440	1496	tCLK
	Width	t_{WH}	16	32	40	
	Width-Active	t_{WHA}	1280	1280	1280	
Vsync	Period	t_{VP}	808	823	840	tHP
	Width	t_{WV}	2	6	6	
	Width-Active	t_{WVA}	800	800	800	
Data Enable	Horizontal back porch	t_{HBP}	68	80	120	tCLK
	Horizontal front porch	t_{HFP}	16	48	56	
	Vertical back porch	t_{VBP}	5	14	32	tHP
	Vertical front porch	t_{VFP}	1	3	2	

3-4. Signal Timing Waveforms

Condition : VCC = 3.3V

Data Enable, Hsync, Vsync

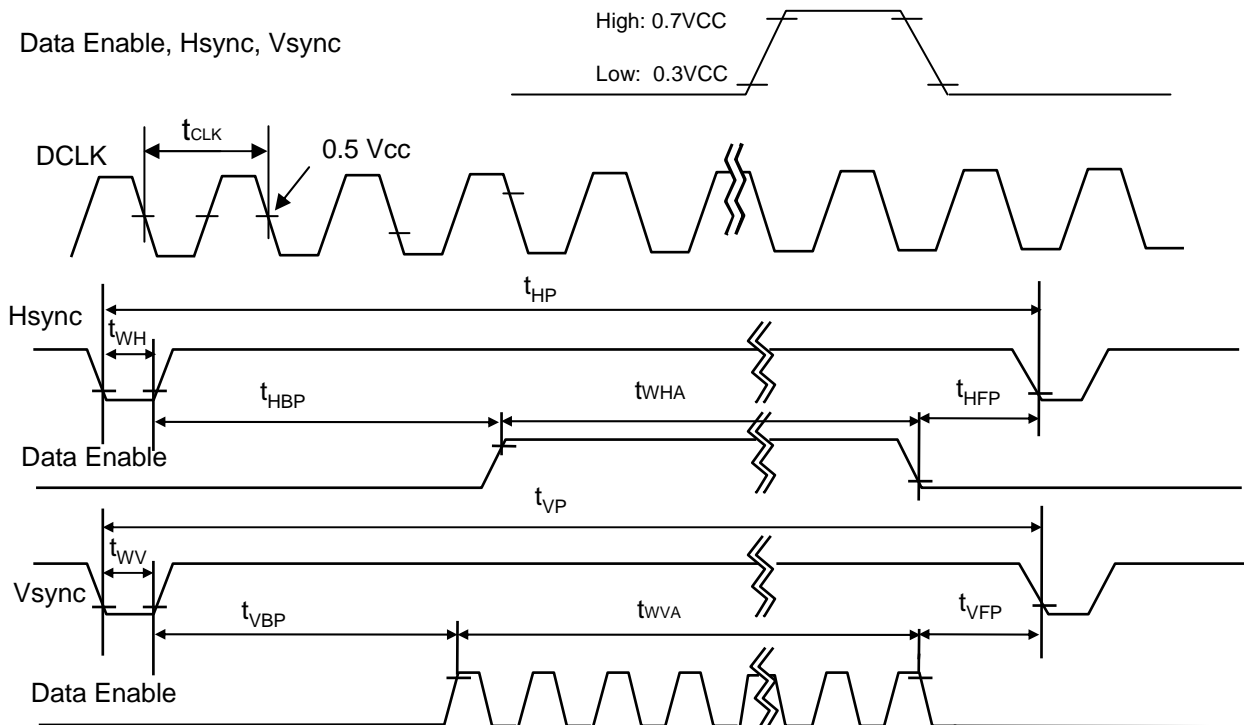

Product Specification

3-5. Color Input Data Reference

The brightness of each primary color (red, green and blue) is based on the 6-bit gray scale data input for the color ; the higher the binary input, the brighter the color. The table below provides a reference for color versus data input.

Table 7. COLOR DATA REFERENCE

Color		Input Color Data																	
		RED						GREEN						BLUE					
		MSB				LSB		MSB				LSB		MSB		LSB			
		R 5	R 4	R 3	R 2	R 1	R 0	G 5	G 4	G 3	G 2	G 1	G 0	B 5	B 4	B 3	B 2	B 1	B 0
Basic Color	Black	0	0	0	0	0	0	0	0	0	0	0	0	0	0	0	0	0	0
	Red	1	1	1	1	1	1	0	0	0	0	0	0	0	0	0	0	0	0
	Green	0	0	0	0	0	0	1	1	1	1	1	1	0	0	0	0	0	0
	Blue	0	0	0	0	0	0	0	0	0	0	0	0	1	1	1	1	1	1
	Cyan	0	0	0	0	0	0	1	1	1	1	1	1	1	1	1	1	1	1
	Magenta	1	1	1	1	1	1	0	0	0	0	0	0	1	1	1	1	1	1
	Yellow	1	1	1	1	1	1	1	1	1	1	1	1	0	0	0	0	0	0
	White	1	1	1	1	1	1	1	1	1	1	1	1	1	1	1	1	1	1
RED	RED (00)	0	0	0	0	0	0	0	0	0	0	0	0	0	0	0	0	0	0
	RED (01)	0	0	0	0	0	1	0	0	0	0	0	0	0	0	0	0	0	0
					
	RED (62)	1	1	1	1	1	0	0	0	0	0	0	0	0	0	0	0	0	0
	RED (63)	1	1	1	1	1	1	0	0	0	0	0	0	0	0	0	0	0	0
GREEN	GREEN (00)	0	0	0	0	0	0	0	0	0	0	0	0	0	0	0	0	0	0
	GREEN (01)	0	0	0	0	0	0	0	0	0	0	0	1	0	0	0	0	0	0
					
	GREEN (62)	0	0	0	0	0	0	1	1	1	1	1	0	0	0	0	0	0	0
	GREEN (63)	0	0	0	0	0	0	1	1	1	1	1	1	0	0	0	0	0	0
BLUE	BLUE (00)	0	0	0	0	0	0	0	0	0	0	0	0	0	0	0	0	0	0
	BLUE (01)	0	0	0	0	0	0	0	0	0	0	0	0	0	0	0	0	0	1
					
	BLUE (62)	0	0	0	0	0	0	0	0	0	0	0	0	1	1	1	1	1	0
	BLUE (63)	0	0	0	0	0	0	0	0	0	0	0	0	1	1	1	1	1	1

3-6. Power Sequence

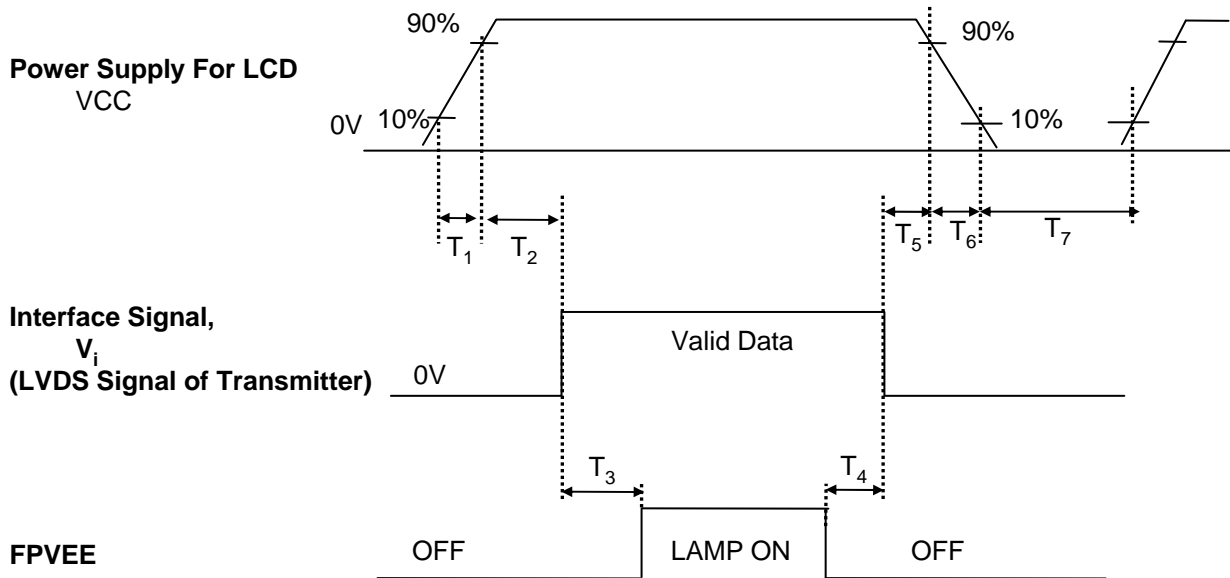

Table 8. POWER SEQUENCE TABLE

Parameter	Value			Units
	Min.	Typ.	Max.	
T_1	-	-	10	(ms)
T_2	0	-	50	(ms)
T_3	200	-	-	(ms)
T_4	200	-	-	(ms)
T_5	0	-	50	(ms)
T_6	-	-	10	(ms)
T_7	400	-	-	(ms)

Note)

1. Please avoid floating state of interface signal at invalid period.
2. When the interface signal is invalid, be sure to pull down the power supply for LCD VCC to 0V.
3. Lamp power must be turn on after power supply for LCD and interface signal are valid.

Product Specification

4. Optical Specification

Optical characteristics are determined after the unit has been 'ON' and stable for approximately 30 minutes in a dark environment at 25°C. The values specified are at an approximate distance 50cm from the LCD surface at a viewing angle of Φ and Θ equal to 0°.

FIG. 1 presents additional information concerning the measurement equipment and method.

FIG. 1 Optical Characteristic Measurement Equipment and Method

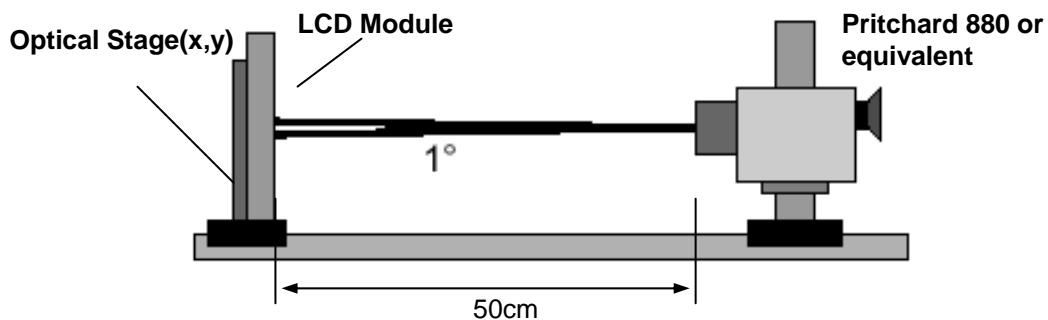

Table 9. OPTICAL CHARACTERISTICS

Ta=25°C, VCC=3.3V, fv=60Hz, fCLK= 71.0MHz, IBL= 6.0mA

Parameter	Symbol	Values			Units	Notes
		Min	Typ	MAx		
Contrast Ratio	CR	350		-		1
Surface Luminance, white	L _{WH}	-	185	-	cd/m ²	2
Luminance Variation	δ_{WHITE}	-	1.85	2.0		3
Response Time						4
Rise Time	T _R	-	6	10	ms	
Delay Time	T _D	-	19	25	ms	
Color Coordinates						
RED	RX	0.552	0.582	0.612		
RY		0.314	0.344	0.374		
GREEN	GX	0.296	0.326	0.356		
GY		0.517	0.547	0.577		
BLUE	BX	0.128	0.158	0.188		
BY		0.107	0.137	0.167		
WHITE	WX	0.283	0.313	0.343		
WY		0.299	0.329	0.359		
Viewing Angle						5
x axis, right($\Phi=0^\circ$)	Θ_r	40	-	-	degree	
x axis, left ($\Phi=180^\circ$)	Θ_l	40	-	-	degree	
y axis, up ($\Phi=90^\circ$)	Θ_u	15	-	-	degree	
y axis, down ($\Phi=270^\circ$)	Θ_d	30	-	-	degree	
Gray Scale						6

Product Specification

Note)

1. Contrast Ratio(CR) is defined mathematically as

$$\text{Contrast Ratio} = \frac{\text{Surface Luminance with all white pixels}}{\text{Surface Luminance with all black pixels}}$$

2. Surface luminance is the average of 5 point across the LCD surface 50cm from the surface with all pixels displaying white. For more information see FIG 1.

$$L_{WH} = \text{Average}(L_1, L_2, \dots L_5)$$

3. The variation in surface luminance , The panel total variation (δ_{WHITE}) is determined by measuring L_N at each test position 1 through 13 and then defined as followed numerical formula.
For more information see FIG 2.

$$\delta_{WHITE} = \frac{\text{Maximum}(L_1, L_2, \dots L_{13})}{\text{Minimum}(L_1, L_2, \dots L_{13})}$$

4. Response time is the time required for the display to transition from white to black (rise time, Tr_R) and from black to white(Decay Time, Tr_D). For additional information see FIG 3.

5. Viewing angle is the angle at which the contrast ratio is greater than 10. The angles are determined for the horizontal or x axis and the vertical or y axis with respect to the z axis which is normal to the LCD surface. For more information see FIG 4.

6. Gray scale specification

* $f_V = 60\text{Hz}$

Gray Level	Luminance [%] (Typ)
L0	0.27
L7	0.95
L15	5.15
L23	13.4
L31	26.2
L39	41.2
L47	59.1
L55	79.0
L63	100

Product Specification

FIG. 2 Luminance

<measuring point for surface luminance & measuring point for luminance variation>

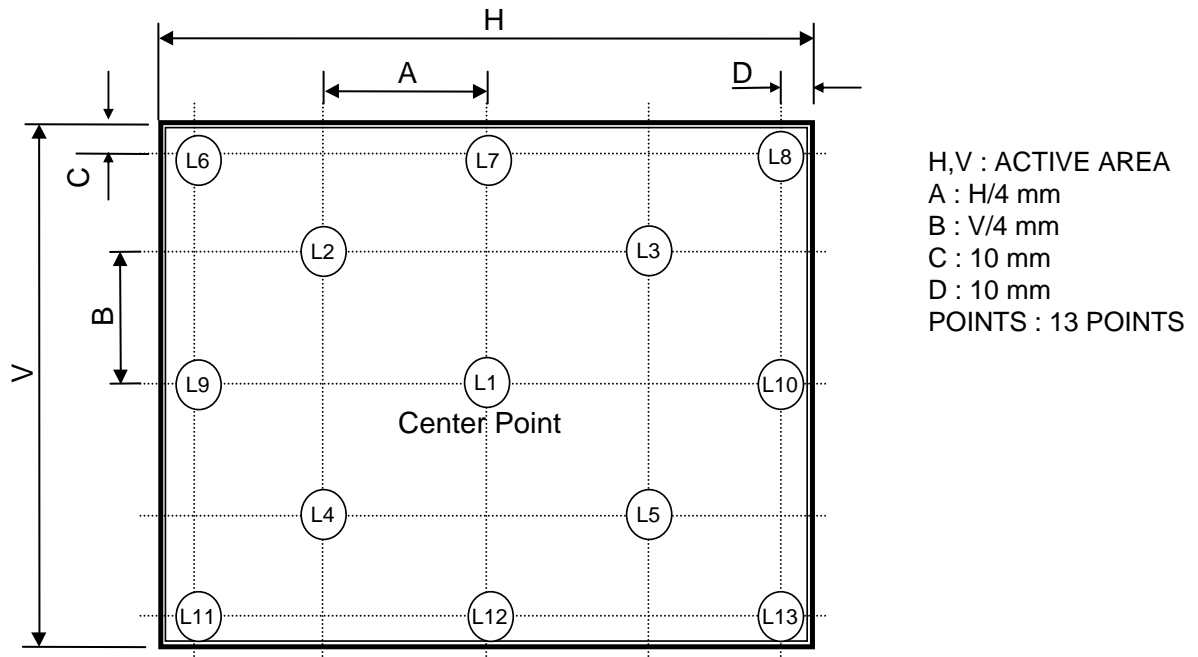
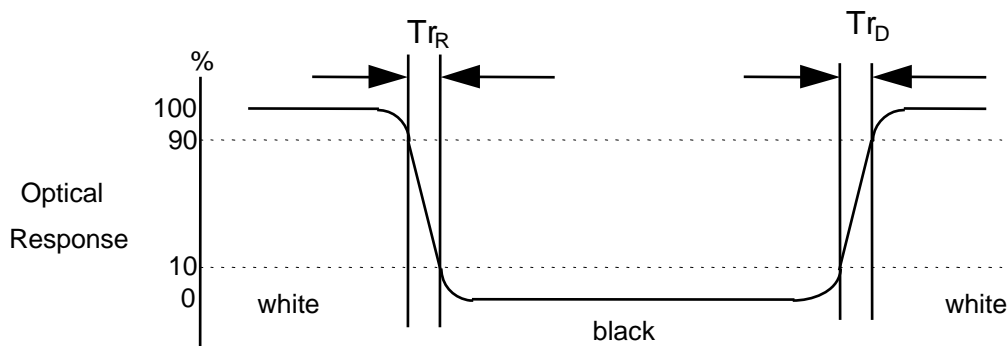

FIG. 3 Response Time

The response time is defined as the following figure and shall be measured by switching the input signal for “black” and “white”.



Product Specification

FIG. 4 Viewing angle

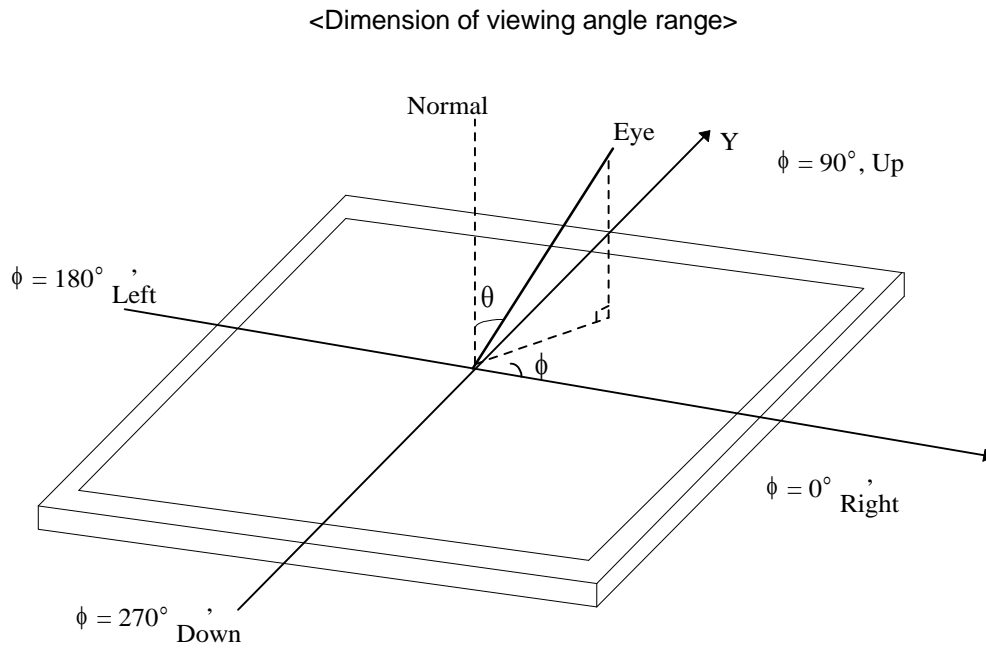

Product Specification

5. Mechanical Characteristics

The contents provide general mechanical characteristics for the model LP141WX1. In addition the figures in the next page are detailed mechanical drawing of the LCD.

Outline Dimension	Horizontal	319.5 ± 0.5mm
	Vertical	205.5 ± 0.5mm
	Depth	5.5mm (max)
Bezel Area	Horizontal	306.76 ± 0.5mm
	Vertical	193 ± 0.5mm
Active Display Area	Horizontal	303.74 mm
	Vertical	189.84 mm
Weight	415g (Typ.) 425g (Max.)	
Surface Treatment	Anti-glare treatment of the front polarizer	

Product Specification

<FRONT VIEW>

Note) Unit:[mm], General tolerance: $\pm 0.5\text{mm}$

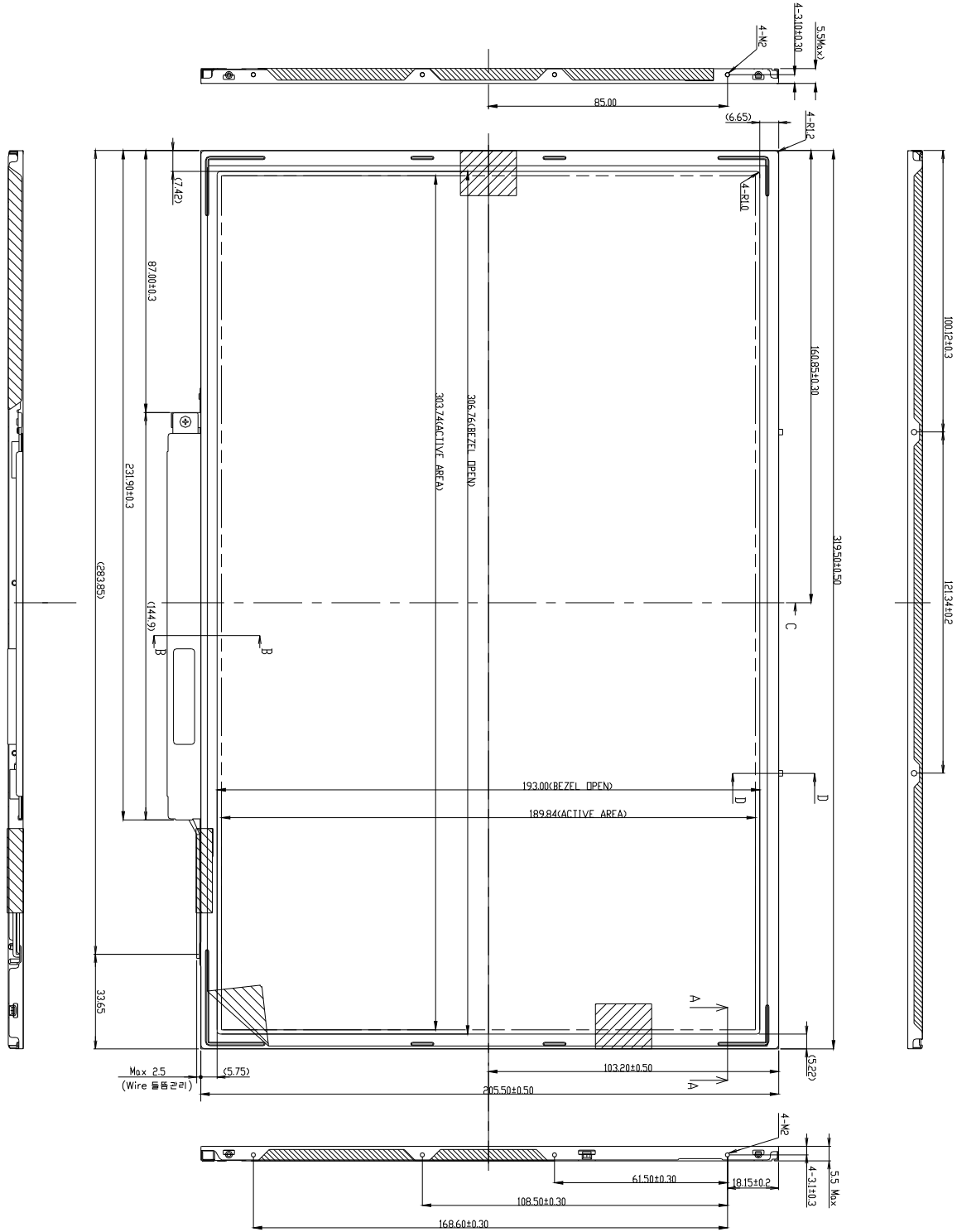

Product Specification

<REAR VIEW>

Note) Unit:[mm], General tolerance: ± 0.5mm

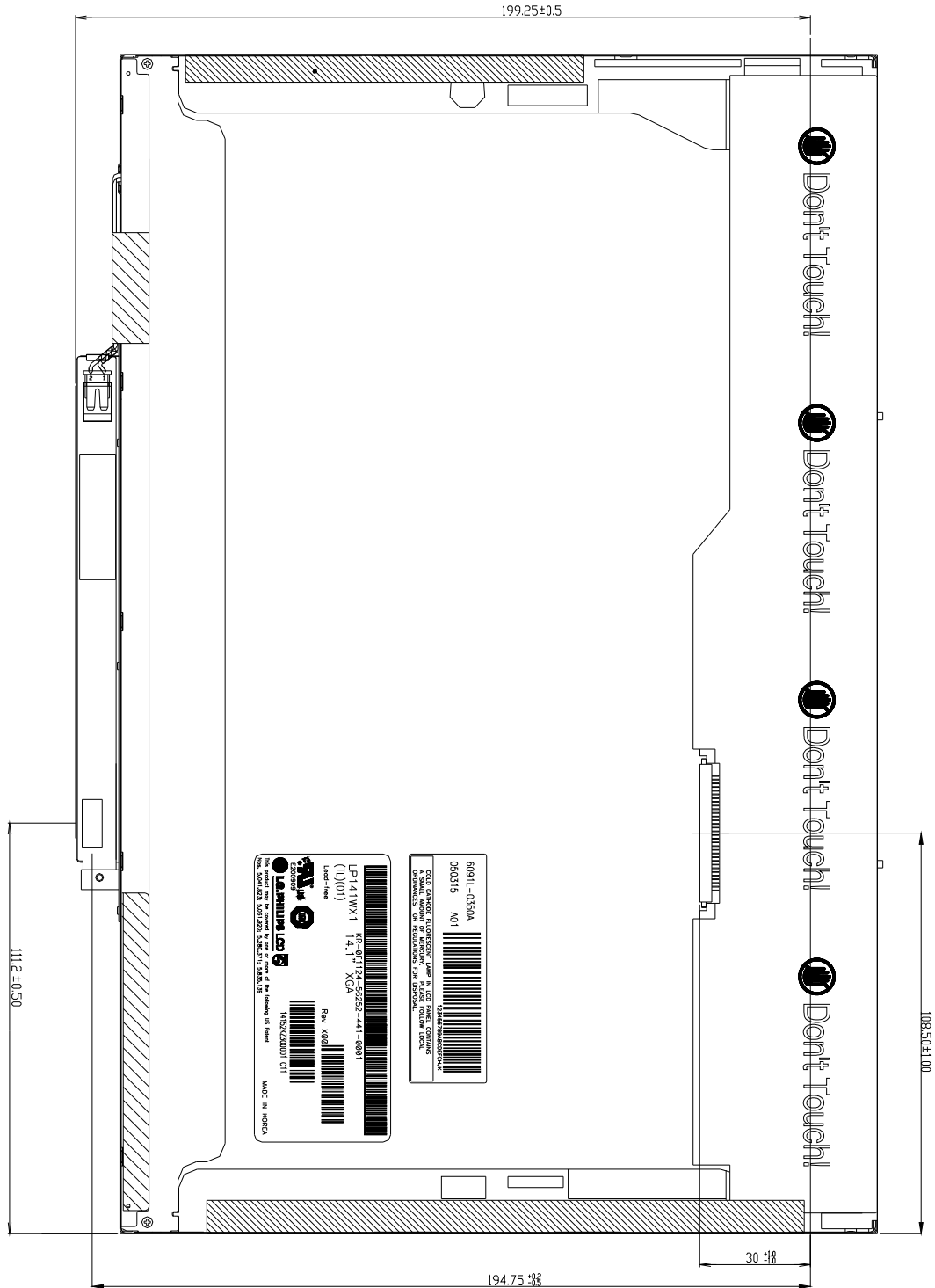

Product Specification

[DETAIL DESCRIPTION OF SIDE MOUNTING SCREW]

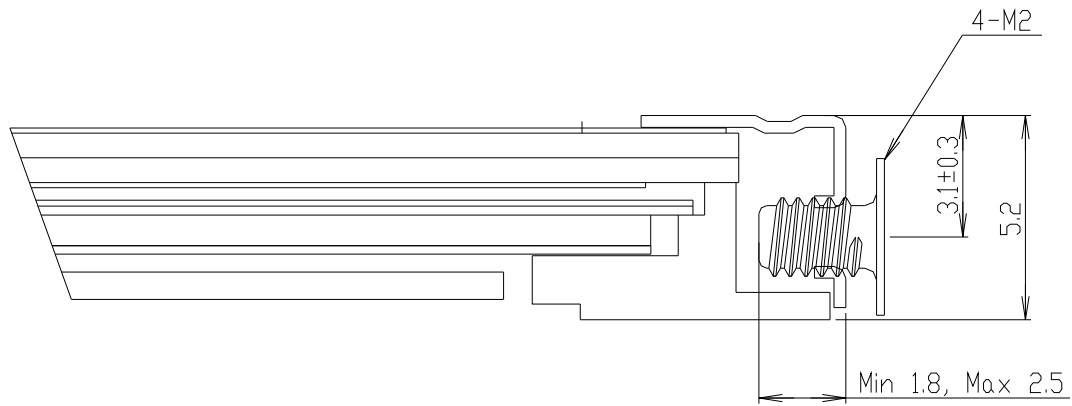

SECTION A-A
SCALE 5/1

*SCREW(8ea) TORQUE : 2kgf.cm max

*Mounting SCREW Depth : 2.5mm max

Note) Unit:[mm], General tolerance: ± 0.5 mm

Product Specification

6. Reliability

Environment test condition

No.	Test Item	Conditions
1	High temperature storage test	Ta= 60°C, 240h
2	Low temperature storage test	Ta= -20°C, 240h
3	High temperature operation test	Ta= 50°C, 50%RH, 240h
4	Low temperature operation test	Ta= 0°C, 240h
5	Vibration test (non-operating)	Sine wave, 10 ~ 500 ~ 10Hz, 1.5G, 0.37oct/min 3 axis, 1hour/axis
6	Shock test (non-operating)	Half sine wave, 180G, 2ms one shock of each six faces(I.e. run 180G 6ms for all six faces)
7	Altitude operating storage / shipment	0 ~ 10,000 feet (3,048m) 24Hr 0 ~ 40,000 feet (12,192m) 24Hr

{ Result Evaluation Criteria }

There should be no change which might affect the practical display function when the display quality test is conducted under normal operating condition.

7. International Standards

7-1. Safety

- a) UL 60950, Third Edition, Underwriters Laboratories, Inc., Dated Dec. 11, 2000.
Standard for Safety of Information Technology Equipment, Including Electrical Business Equipment.
- b) CAN/CSA C22.2, No. 60950, Third Edition, Canadian Standards Association, Dec. 1, 2000.
Standard for Safety of Information Technology Equipment, Including Electrical Business Equipment.
- c) EN 60950 : 2000, Third Edition
IEC 60950 : 1999, Third Edition
European Committee for Electrotechnical Standardization(CENELEC)
EUROPEAN STANDARD for Safety of Information Technology Equipment Including Electrical Business Equipment.

7-2. EMC

- a) ANSI C63.4 "Methods of Measurement of Radio-Noise Emissions from Low-Voltage Electrical and Electrical Equipment in the Range of 9kHz to 40GHz." American National Standards Institute(ANSI), 1992
- b) C.I.S.P.R "Limits and Methods of Measurement of Radio Interface Characteristics of Information Technology Equipment." International Special Committee on Radio Interference.
- c) EN 55022 "Limits and Methods of Measurement of Radio Interface Characteristics of Information Technology Equipment." European Committee for Electrotechnical Standardization.(CENELEC), 1998
(Including A1: 2000)

Product Specification

8. Packing

8-1. Designation of Lot Mark

a) Lot Mark

A	B	C	D	E	F	G	H	I	J	K	L	M
---	---	---	---	---	---	---	---	---	---	---	---	---

A,B,C : SIZE(INCH)

E : MONTH

G : ASSEMBLY CODE

D : YEAR

F : FACTORY CODE

H ~ M : SERIAL NO.

Note

1. YEAR

Year	2001	2002	2003	2004	2005	2006	2007	2008	2009	2010
Mark	1	2	3	4	5	6	7	8	9	0

2. MONTH

Month	Jan	Feb	Mar	Apr	May	Jun	Jul	Aug	Sep	Oct	Nov	Dec
Mark	1	2	3	4	5	6	7	8	9	A	B	C

3. FACTORY CODE

Factory Code	LPL Gumi	LPL Nanjing	HEESUNG
Mark	K	C	D

4. SERIAL NO.

Mark	100001~199999, 200001~299999, 300001~399999,, A00001~A99999,, Z00001~Z99999
------	---

b) Location of Lot Mark

Serial No. is printed on the label. The label is attached to the backside of the LCD module.
This is subject to change without prior notice.

8-2. Packing Form

a) Package quantity in one box : 20ea

b) Box Size : 430 X 334 X 287

9. PRECAUTIONS

Please pay attention to the followings when you use this TFT LCD module.

9-1. MOUNTING PRECAUTIONS

- (1) You must mount a module using holes arranged in four corners or four sides.
- (2) You should consider the mounting structure so that uneven force (ex. Twisted stress) is not applied to the module. And the case on which a module is mounted should have sufficient strength so that external force is not transmitted directly to the module.
- (3) Please attach the surface transparent protective plate to the surface in order to protect the polarizer. Transparent protective plate should have sufficient strength in order to resist external force.
- (4) You should adopt radiation structure to satisfy the temperature specification.
- (5) Acetic acid type and chlorine type materials for the cover case are not desirable because the former generates corrosive gas of attacking the polarizer at high temperature and the latter causes circuit break by electro-chemical reaction.
- (6) Do not touch, push or rub the exposed polarizers with glass, tweezers or anything harder than HB pencil lead. And please do not rub with dust clothes with chemical treatment. Do not touch the surface of polarizer for bare hand or greasy cloth. (Some cosmetics are detrimental to the polarizer.)
- (7) When the surface becomes dusty, please wipe gently with absorbent cotton or other soft materials like chamois soaks with petroleum benzene. Normal-hexane is recommended for cleaning the adhesives used to attach front / rear polarizers. Do not use acetone, toluene and alcohol because they cause chemical damage to the polarizer.
- (8) Wipe off saliva or water drops as soon as possible. Their long time contact with polarizer causes deformations and color fading.
- (9) Do not open the case because inside circuits do not have sufficient strength.

9-2. OPERATING PRECAUTIONS

- (1) The spike noise causes the mis-operation of circuits. It should be lower than following voltage :
 $V = \pm 200\text{mV}$ (Over and under shoot voltage)
- (2) Response time depends on the temperature. (In lower temperature, it becomes longer.)
- (3) Brightness depends on the temperature. (In lower temperature, it becomes lower.)
And in lower temperature, response time (required time that brightness is stable after turned on) becomes longer.
- (4) Be careful for condensation at sudden temperature change. Condensation makes damage to polarizer or electrical contacted parts. And after fading condensation, smear or spot will occur.
- (5) When fixed patterns are displayed for a long time, remnant image is likely to occur.
- (6) Module has high frequency circuits. Sufficient suppression to the electromagnetic interference shall be done by system manufacturers. Grounding and shielding methods may be important to minimize the interference.

9-3. ELECTROSTATIC DISCHARGE CONTROL

Since a module is composed of electronic circuits, it is not strong to electrostatic discharge. Make certain that treatment persons are connected to ground through wrist band etc. And don't touch interface pin directly.

9-4. PRECAUTIONS FOR STRONG LIGHT EXPOSURE

Strong light exposure causes degradation of polarizer and color filter.

9-5. STORAGE

When storing modules as spares for a long time, the following precautions are necessary.

- (1) Store them in a dark place. Do not expose the module to sunlight or fluorescent light. Keep the temperature between 5°C and 35°C at normal humidity.
- (2) The polarizer surface should not come in contact with any other object.
It is recommended that they be stored in the container in which they were shipped.

9-6. HANDLING PRECAUTIONS FOR PROTECTION FILM

- (1) When the protection film is peeled off, static electricity is generated between the film and polarizer. This should be peeled off slowly and carefully by people who are electrically grounded and with well ion-blown equipment or in such a condition, etc.
- (2) The protection film is attached to the polarizer with a small amount of glue. If some stress is applied to rub the protection film against the polarizer during the time you peel off the film, the glue is apt to remain on the polarizer.
Please carefully peel off the protection film without rubbing it against the polarizer.
- (3) When the module with protection film attached is stored for a long time, sometimes there remains a very small amount of glue still on the polarizer after the protection film is peeled off.
- (4) You can remove the glue easily. When the glue remains on the polarizer surface or its vestige is recognized, please wipe them off with absorbent cotton waste or other soft material like chamois soaked with normal-hexane.

Product Specification

APPENDIX A. Enhanced Extended Display Identification Data (EEDID™) 1/3

	Byte	Field Name and Comments	Value	Value
	(hex)		(hex)	(binary)
Header	0	Header	00	00000000
	1	Header	FF	11111111
	2	Header	FF	11111111
	3	Header	FF	11111111
	4	Header	FF	11111111
	5	Header	FF	11111111
	6	Header	FF	11111111
	7	Header	00	00000000
Vendor/Product EDID Version	8	EISA manufacture code = LPL	32	00110010
	9	EISA manufacture code (Compressed ASCII)	0C	00001100
	0A	Panel Supplier Reserved – Product Code	00	00000000
	0B	Panel Supplier Reserved – Product Code	00	00000000
	0C	LCD module Serial No - Preferred but Optional (“0” if not used)	00	00000000
	0D	LCD module Serial No - Preferred but Optional (“0” if not used)	00	00000000
	0E	LCD module Serial No - Preferred but Optional (“0” if not used)	00	00000000
	0F	LCD module Serial No - Preferred but Optional (“0” if not used)	00	00000000
	10	Week of manufacture	00	00000000
	11	Year of manufacture = 2005	0F	00001111
	12	EDID structure version # = 1	01	00000001
	13	EDID revision # = 3	03	00000011
	Display Parameters	14	Video I/P definition = Digital I/P (80h)	80
15		Max H image size = (Rounded to cm)	1E	00011110
16		Max V image size = (Rounded to cm)	13	00010011
17		Display gamma = (gamma ×100)-100 = Example: (2.2×100) – 100 = 120	78	01111000
18		Feature support (no DPMS, Active off, RGB, timing BLK 1)	0A	00001010
Panel Color Coordinates	19	Red/Green Low bit (RxRy/GxGy)	C4	11000100
	1A	Blue/White Low bit (BxBy/WxWy)	40	01000000
	1B	Red X Rx = 0.582	94	10010100
	1C	Red Y Ry = 0.344	58	01011000
	1D	Green X Gx = 0.326	53	01010011
	1E	Green Y Gy = 0.547	8C	10001100
	1F	Blue X Bx = 0.158	28	00101000
	20	Blue Y By = 0.137	23	00100011
	21	White X Wx = 0.313	50	01010000
	22	White Y Wy = 0.329	54	01010100
Established Timings	23	Established timings 1 (00h if not used)	00	00000000
	24	Established timings 2 (00h if not used)	00	00000000
	25	Manufacturer's timings (00h if not used)	00	00000000
Standard Timing ID	26	Standard timing ID1 (01h if not used)	01	00000001
	27	Standard timing ID1 (01h if not used)	01	00000001
	28	Standard timing ID2 (01h if not used)	01	00000001
	29	Standard timing ID2 (01h if not used)	01	00000001
	2A	Standard timing ID3 (01h if not used)	01	00000001
	2B	Standard timing ID3 (01h if not used)	01	00000001
	2C	Standard timing ID4 (01h if not used)	01	00000001
	2D	Standard timing ID4 (01h if not used)	01	00000001
	2E	Standard timing ID5 (01h if not used)	01	00000001
	2F	Standard timing ID5 (01h if not used)	01	00000001
	30	Standard timing ID6 (01h if not used)	01	00000001
	31	Standard timing ID6 (01h if not used)	01	00000001
	32	Standard timing ID7 (01h if not used)	01	00000001
	33	Standard timing ID7 (01h if not used)	01	00000001
	34	Standard timing ID8 (01h if not used)	01	00000001
	35	Standard timing ID8 (01h if not used)	01	00000001

Product Specification

APPENDIX A. Enhanced Extended Display Identification Data (EEDID™) 2/3

	Byte	Field Name and Comments	Value	Value
	(hex)		(hex)	(binary)
Timing Descriptor #1	36	Pixel Clock/10,000 71MHz (LSB)	BC	10111100
	37	Pixel Clock/10,000 (MSB)	1B	00011011
	38	Horizontal Active = 1280 pixels (lower 8 bits)	00	00000000
	39	Horizontal Blanking (Thbp) = 160 pixels (lower 8 bits)	A0	10100000
	3A	Horizontal Active/Horizontal blanking (Thbp) (upper4:4 bits)	50	01010000
	3B	Vertical Active = 800 lines	20	00100000
	3C	Vertical Blanking (Tvbp) = 23 lines (DE Blanking typ. for DE only panels)	17	00010111
	3D	Vertical Active : Vertical Blanking (Tvbp) (upper4:4 bits)	30	00110000
	3E	Horizontal Sync, Offset (Thfp) = 48 pixels	30	00110000
	3F	Horizontal Sync, Pulse Width = 32 pixels	20	00100000
	40	Vertical Sync, Offset (Tvfp) = 3 lines Sync Width = 6 lines	36	00110110
	41	Horizontal Vertical Sync Offset/Width upper 2 bits	00	00000000
	42	Horizontal Image Size =303.74 mm	30	00110000
	43	Vertical image Size = 189.84 mm	BE	10111110
	44	Horizontal Image Size / Vertical image size	10	00010000
	45	Horizontal Border = 0 (Zero for Notebook LCD)	00	00000000
	46	Vertical Border = 0 (Zero for Notebook LCD)	00	00000000
47	Non-interlaced, Normal, no stereo, Separate sync, H/V pol Negatives, DE only note: LSB is set to "1" if panel is DE-timing only, H/V can be ignored.	18	00011000	
Timing Descriptor #2	48	Pixel Clock/10,000 71MHz (LSB)	BC	10111100
	49	Pixel Clock/10,000 (MSB)	1B	00011011
	4A	Horizontal Active = 1280 pixels (lower 8 bits)	00	00000000
	4B	Horizontal Blanking (Thbp) = 160 pixels (lower 8 bits)	A0	10100000
	4C	Horizontal Active/Horizontal blanking (Thbp) (upper4:4 bits)	50	01010000
	4D	Vertical Active = 800 lines	20	00100000
	4E	Vertical Blanking (Tvbp) = 23 lines (DE Blanking typ. for DE only panels)	17	00010111
	4F	Vertical Active : Vertical Blanking (Tvbp) (upper4:4 bits)	30	00110000
	50	Horizontal Sync, Offset (Thfp) = 48 pixels	30	00110000
	51	Horizontal Sync, Pulse Width = 32 pixels	20	00100000
	52	Vertical Sync, Offset (Tvfp) = 3 lines Sync Width = 6 lines	36	00110110
	53	Horizontal Vertical Sync Offset/Width upper 2 bits	00	00000000
	54	Horizontal Image Size =303.74 mm	30	00110000
	55	Vertical image Size = 189.84 mm	BE	10111110
	56	Horizontal Image Size / Vertical image size	10	00010000
	57	Horizontal Border = 0 (Zero for Notebook LCD)	00	00000000
	58	Vertical Border = 0 (Zero for Notebook LCD)	00	00000000
59	Module "A" Revision = Example: 00, 01, 02, 03, etc.	00	00000000	
Timing Descriptor #3 Dell specific information	5A	Flag	00	00000000
	5B	Flag	00	00000000
	5C	Flag	00	00000000
	5D	Dummy Descriptor	FE	11111110
	5E	Flag	00	00000000
	5F	Dell P/N 1 st Character = H	48	01001000
	60	Dell P/N 2 nd Character = D	44	01000100
	61	Dell P/N 3 rd Character = 4	34	00110100
	62	Dell P/N 4 th Character = 0	30	00110000
	63	Dell P/N 5 th Character = 0	30	00110000
	64	LCD Supplier EEDID Revision # = 0.8	08	00001000
	65	Manufacturer P/N = 1	31	00110001
	66	Manufacturer P/N = 4	34	00110100
	67	Manufacturer P/N = 1	31	00110001
	68	Manufacturer P/N = W	57	01010111
	69	Manufacturer P/N = X	58	01011000
	6A	Manufacturer P/N = 1	31	00110001
6B	Manufacturer P/N (If <13 char, then terminate with ASCII code 0Ah, set remaining char = 20h)	0A	00001010	

Product Specification

APPENDIX A. Enhanced Extended Display Identification Data (EEDID™) 3/3

	Byte	Field Name and Comments	Value	Value
	(hex)		(hex)	(binary)
Timing Descriptor #4	6C	Flag	00	00000000
	6D	Flag	00	00000000
	6E	Flag	00	00000000
	6F	Data Type Tag:	FE	11111110
	70	Flag	00	00000000
	71	SMBUS Value = 10 nits	D8	11011000
	72	SMBUS Value = 17 nits	C8	11001000
	73	SMBUS Value = 24 nits	B8	10111000
	74	SMBUS Value = 30 nits	B0	10110000
	75	SMBUS Value = 60 nits	88	10001000
	76	SMBUS Value = 110 nits	68	01101000
	77	SMBUS Value = 150 nits	48	01001000
	78	SMBUS Value = 185 nits (Typically = 00h, 185 nits)	28	00101000
	79	Number of LVDS receiver chips = '01' or '02'	01	00000001
	7A	BIST Enable: Yes = '01' No = '00'	01	00000001
7B	(If <13 char, then terminate with ASCII code 0Ah, set remaining char = 20h)	0A	00001010	
7C	(If <13 char, then terminate with ASCII code 0Ah, set remaining char = 20h)	20	00100000	
7D	(If <13 char, then terminate with ASCII code 0Ah, set remaining char = 20h)	20	00100000	
Checksum	7E	Extension flag (# of optional 128 EDID extension blocks to follow, Typ = 0)	00	00000000
	7F	Checksum (The 1-byte sum of all 128 bytes in this EDID block shall = 0)	E0	11100000